



2019 QWEST | ESTEEM | ODYSSEY

2019 CLASS C



ENTEGRACOACH®

enjoy the journey



YOUR VOYAGE
BEGINS HERE



QWEST PG 3-4

ESTEEM PG 5-6

ODYSSEY PG 7-8

ODYSSEY



ESTEEM



ENTEGRA
COACH®

E-Z Drive® is a powerful blend of precise handling and renowned stability. Hands down, it's the best ride. **Experience E-Z Drive for yourself—visit your local dealer and take a test drive.**

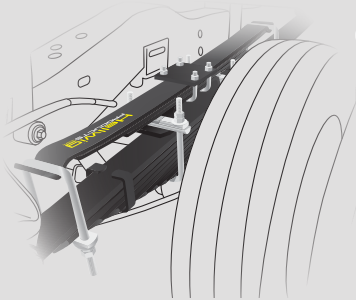

HELLWIG® HELPER SPRINGS

Work with the chassis' existing springs to give the RV more support, improving stability under heavy loads

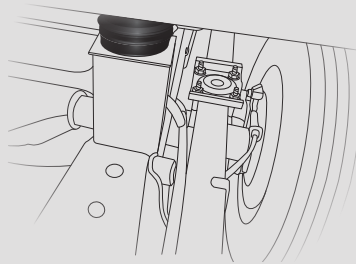

RUBBER ISOLATION MOUNTS

Positioned near the tires to absorb road shock, dampen noise and minimize vibrations

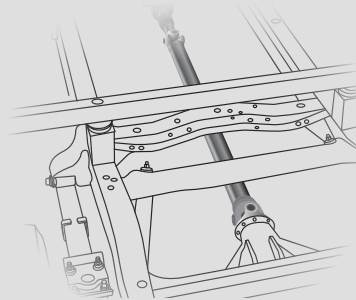

COMPUTER-BALANCED DRIVESHAFT

Ensures smooth and efficient power transfer to the wheels

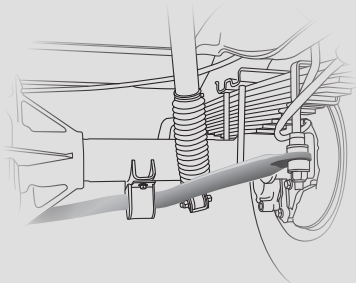

STABILIZER BAR(S)

Reduces the body roll of a vehicle during fast cornering or over road irregularities

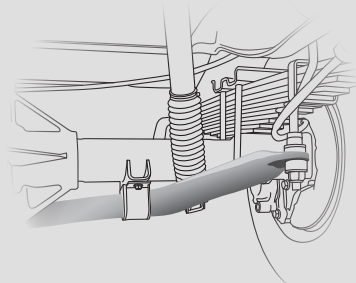

HEAVY-DUTY REAR STABILIZER BAR

A larger bar and polyurethane bushings, instead of rubber, transfer power faster for extra support, more stability and easier handling

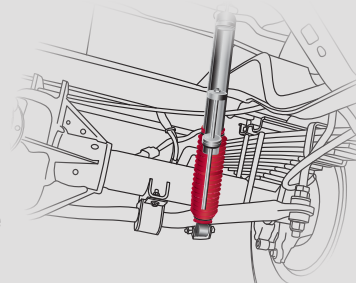

BILSTEIN® SHOCK ABSORBERS

Feature a unique monotube gas-pressure design, providing optimum ride quality and vehicle control

QWEST



TOP FEATURES

- Luxury Woven Vinyl Flooring
- European Style Curved Cabinetry
- 3-Way (Gas/Electric/12V) Refrigerator
- Stainless Convection Microwave



FLOORPLANS

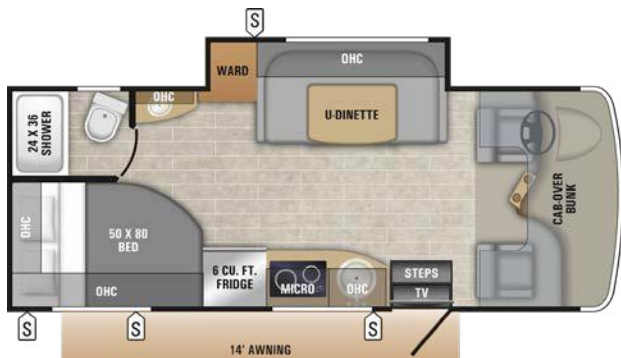

24A



24K

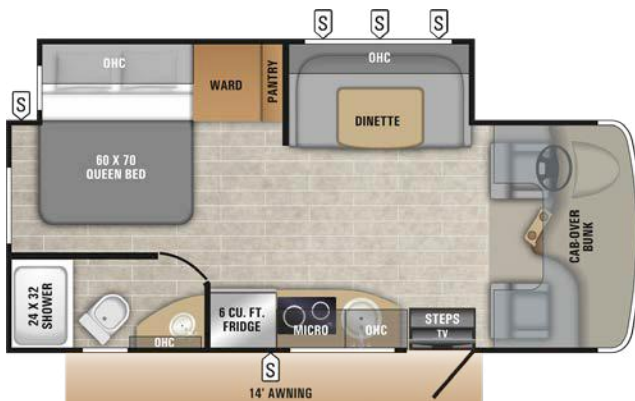

24L

EXTERIOR OPTIONS

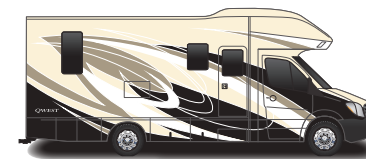

CLIFF CREST



ESCAPE



SKY WATCH

INTERIOR OPTIONS

SOLSTICE

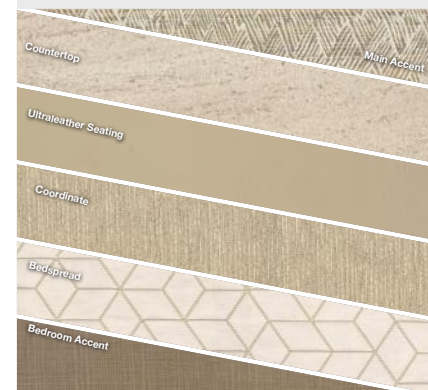

WOOD



HUDSON ELM

Floorplan	GVWR (lbs.)	GCWR (lbs.)	Wheel Base	Overall Length	Exterior Height w/ A/C	Exterior Width	Interior Height	Fresh Water Capacity (gal.)	Grey Waste Water Capacity (gal.)	Black Waste Water Capacity (gal.)	Propane (gal.)
24A	11,030	15,250	170"	25' 2"	10' 11"	96"	80"	39	31	31	12.2
24K	11,030	15,250	170"	25' 2"	10' 11"	96"	80"	43	31	31	12.2
24L	11,030	15,250	170"	25' 2"	10' 11"	96"	80"	43	31	31	12.2

ESTEEM



TOP FEATURES

- Raised Panel Cabinetry
- Stainless Appliance Package
- Pull-Out Countertop Extension (Select Models)
- Solid-Surface Countertops



FLOORPLANS

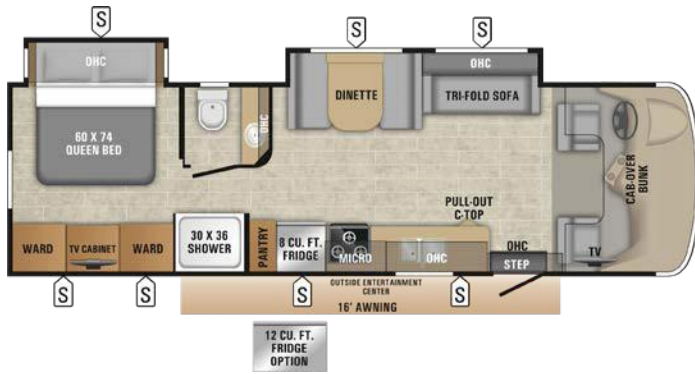

29V

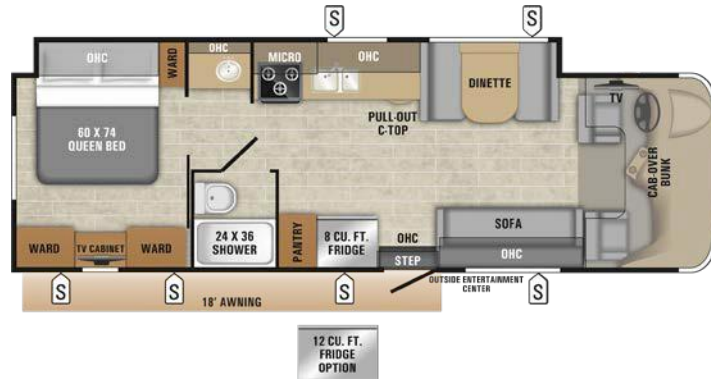

30X



31L

Floorplan	GVWR (lbs.)	GCWR (lbs.)	Wheel Base	Overall Length	Exterior Height w/ A/C	Exterior Width	Interior Height	Fresh Water Capacity (gal.)	Grey Waste Water Capacity (gal.)	Black Waste Water Capacity (gal.)	Propane (gal.)
29V	14,500	22,000	223"	32' 6"	11' 6"	100"	84"	47	41	32	16.5
30X	14,500	22,000	223"	32' 6"	11' 6"	100"	84"	47	41	31	16.5
31L	14,500	22,000	223"	32' 6"	11' 6"	100"	84"	47	41	32	16.5

EXTERIOR OPTIONS



CAREFREE



CHAMPAGNE



VOYAGE

INTERIOR OPTIONS

BELMONT

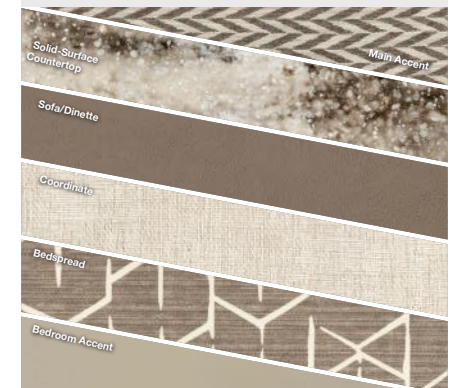

WOOD



VAGABOND

ODYSSEY



TOP FEATURES

- 30" x 82" Panoramic Front Window
- Stainless Steel Sinks
- Front Overhead Bunk Rated 750Lb. Capacity
- Stainless Appliance Package



FLOORPLANS

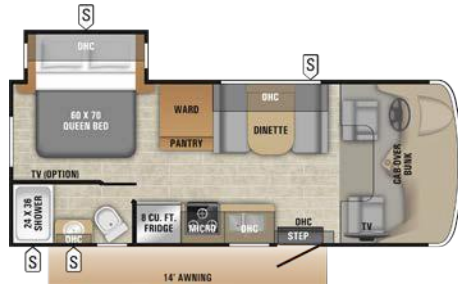

22J



24B

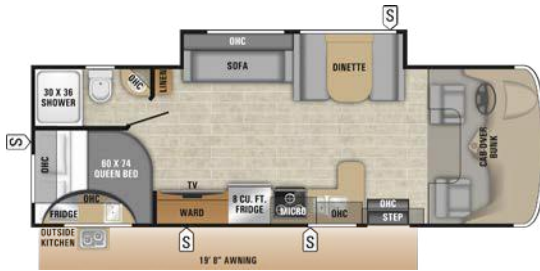

25R



26D



29V



31L

Floorplan	GVWR (lbs.)	GCWR (lbs.)	Wheel Base	Overall Length	Exterior Height w/ A/C	Exterior Width	Interior Height	Fresh Water Capacity (gal.)	Grey Waste Water Capacity (gal.)	Black Waste Water Capacity (gal.)	Propane (gal.)
22J	14,500	22,000	158"	24' 8"	11' 6"	100"	84"	43.5	40	31	12.2
24B	14,500	22,000	181"	26' 8"	11' 6"	100"	84"	47	40	31	12.2
25R	14,500	22,000	181"	28' 8"	11' 6"	100"	84"	47	41	32	12.2
26D	14,500	22,000	181"	28' 8"	11' 6"	100"	84"	42.5	42.5	41	12.2
29V	14,500	22,000	223"	32' 6"	11' 6"	100"	84"	47	41	32	12.2
31L	14,500	22,000	223"	32' 6"	11' 6"	100"	84"	47	41	32	12.2

EXTERIOR OPTIONS



STANDARD

INTERIOR OPTIONS

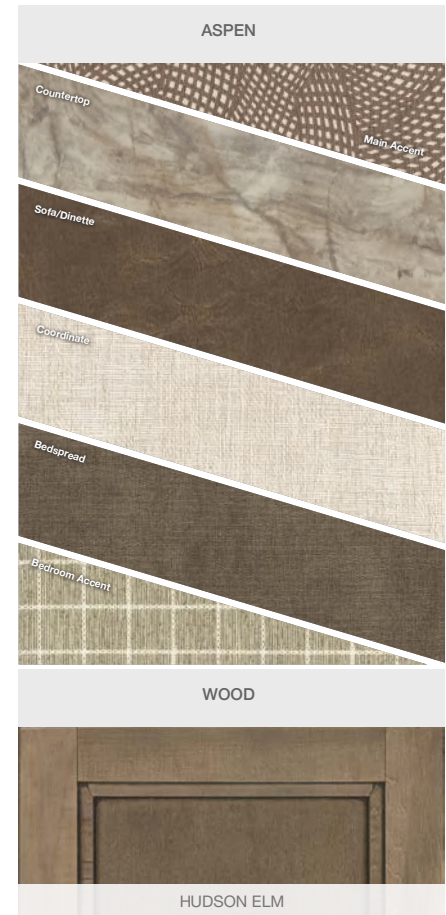

QWEST STANDARDS & OPTIONS

CUSTOMER VALUE PACKAGE

Sony® infotainment dash radio with GPS
One-piece seamless fiberglass front cap
Automatic electric stabilizer jacks
Remote control and heated mirrors
backup camera with monitor
12V tank heating pads
Frameless windows
Girard® armless electric patio awning with LED light strip
Swivel driver and passenger seats
Keyless cab entry

STANDARD DRIVING EQUIPMENT

Mercedes 3500 chassis 170" wheelbase
V-6 Turbo 188 HP diesel engine with electronic fuel injection and 325 lb.-ft. torque
5-speed automatic transmission
11,030-lb GVWR chassis
7-pin trailer hitch plug
26.4-gallon fuel tank
5,000-lb. rear hitch receiver with dual connector
220-amp alternator
Front and rear disc, 4-wheel anti-lock brakes
Ultraleather® driver passenger seats
12V chassis battery
Cab area privacy curtain

STANDARD EXTERIOR EQUIPMENT

Full-Body Paint
One-piece fiberglass front cap
One-piece fiberglass roof
Electric-powered, single-entrance step
Fiberglass running boards
Flush-mount LED marker lights
Backup/Reverse lights
Brake lights
Third brake light
Aluminum skirt-hung baggage doors
110V GFCI exterior receptacles
1,000-Watt Inverter
Battery disconnect
30-amp detachable electrical service cord
60 amp 12V converter
3.6 KW Onan® LP generator
2-12V house batteries
12.2-gal. propane tank
Black tank sprayer
Outside shower
LP quick-connect hookup
Aluminum rims

STANDARD INTERIOR EQUIPMENT

Soft touch vinyl ceiling
Ball bearing drawer guides
European style curved cabinetry
6 cu. ft. gas/electric/12 volt refrigerator
Suburban black 2-burner drop-in cooktop with flush cover
Stainless convection microwave
Stainless steel sink
Wooden sink cover/cutting board
12V demand water pump
6 gallon gas/electric water heater and water heater bypass
Digital antenna with signal booster
15,000-BTU low-profile air conditioner
Auto-ignition 20,000-BTU ducted furnace
Water filtration system
12V USB charging station
Entegra-exclusive easy operation legless dinette table (24K)
U-shaped dinette with stow away pedestal legs (24L, 24A)
Lap safety belts on living area seats
Woven Vinyl Flooring
High-intensity LED ceiling lights
Day/Night roller shades
Vent fan in living room
32" LED living room TV
Cable TV hookup with RG-6 coax
Satellite dish prep
Porcelain toilet
Shower skylight
Bathroom electric roof vent
Queen size bed with bedspread
Bedroom TV Prep
Overhead bunk (750-lb. rating)

OPTIONS

Sun folding windshield shade
3.2 KW diesel generator
B-Plus front cap

ESTEEM STANDARDS & OPTIONS

CUSTOMER VALUE PACKAGE

EZDRIVE ELITE: Computer balanced drive shaft, Bilstein® shocks, heavy-duty rear stabilizer bar, standard front stabilizer bar, Hellwig® helper springs, rubber isolation mounts
Sony Infotainment Dash Radio with GPS
One-piece seamless fiberglass front cap

Automatic hydraulic leveling jacks
Chrome, remote-controlled and heated mirrors
Backup and side-view cameras
Frameless Windows
1000-watt inverter
Electric awning with LED lights
Exterior 32" LED TV
24" LED TV in Bedroom
Solid-surface kitchen countertops with sink covers
One-piece seamless front cap with 30"x82" automotive-bonded panoramic front window
Keyless cab entry

STANDARD DRIVING EQUIPMENT

Ford® E-450 chassis
Triton® 6.8L EFI V-10 305HP engine with 420 lb.-ft. torque
6-speed automatic TorqShift series transmission with overdrive
14,500-pound GVWR
22,000-pound GCWR
7,500-pound hitch with 750-lb tongue capacity and 7-pin plug
55-gallon fuel tank
120-amp alternator
Driver and passenger air bags
Power anti-lock brakes with power steering
Tilt steering wheel
Auxiliary start switch
A/C and cruise control
Power windows and door locks
Wheel liners
Custom dash applique

STANDARD EXTERIOR EQUIPMENT

TuffShell™ vacuum-bonded, laminated floor, sidewalls and roof
White fiberglass exterior with vinyl graphics
Bead-foam insulation (R-24 max roof, R-9 max floor, R-5 max walls)
One-piece seamless fiberglass roof
Fiberglass, radius-cornered entrance door with large window
Electric-powered entrance step
Fiberglass running boards and transition wings
LED taillights
Third brake light
Locking exterior storage compartments
120V GFCI-protected exterior receptacle
12V electrical system with 120V, 60-amp power converter
Illuminated battery disconnect switch

30-amp power cord
32" Exterior TV
High-output, marine grade exterior speakers
Onan 4,000-watt MicroQuiet™ generator with auto-changeover
12V house battery
16.5 gal. propane tank
Black tank sprayer
Outside shower
4-inch bumper-tube with sewer hose storage
Heated holding tanks (12V pads)

STANDARD INTERIOR EQUIPMENT

Raised panel cabinetry
Hardwood fascia
8-cubic-foot, flush-mount, double door refrigerator
3-burner range with 9,000-BTU SuperBurner™ recessed with solid-surface covers
Oven
Stainless steel sink in kitchen
12V demand water pump
6 gallon gas/electric DSI auto-ignition water heater
Interior command center
15,000-BTU A/C with heat pump
31,000-BTU auto-ignition furnace with wall thermostat
Light in wardrobe
Water filtration system
Entegra-exclusive easy operation legless dinette table
Vinyl flooring throughout
High-intensity, recessed LED ceiling lights
Black out night roller shades
32-inch digital LED HDTV
Cable TV hookup with RG-6 coax
Satellite dish prep
Stainless steel sink in bathroom
Porcelain toilet with foot flush
Shower with decorative surround and glass shower door
Skylight in shower
Queen-sized bed with bedspread
Under-bed storage
24" LED TV in bedroom
Fan-Tastic Fan in bedroom
Full 750-pound overhead bunk capacity

OPTIONS

Carefree full body paint
Voyage full body paint
Champagne full body paint

(2) 24" LED TV's in bunk area with CD/DVD players (31L Only)
 12 cu.ft. Refrigerator (29V, 30X)
 11,000-BTU A/Cs (2) with energy management system
 Aluminum rims

ODYSSEY STANDARDS & OPTIONS

CUSTOMER VALUE PACKAGE

EZDRIVE: Computer-balanced driveshaft, standard front and rear stabilizer bars, Hellwig helper springs, rubber isolation body mounts
 Soundstream Infotainment Dash Radio with GPS and CD/DVD Player
 One-piece seamless fiberglass front cap with 30" x 82" front windshield
 12V electric patio awning
 Black holding tank sprayer
 Rear back-up camera and monitor
 Heated holding tanks (12V pads)
 8 cu. ft. flush-mount, double-door refrigerator
 32" LED HDTV
 Keyless cab entry

STANDARD DRIVING EQUIPMENT

Ford E-450 chassis
 Triton 6.8L EFI V-10 305 HP engine with 420 lbs.-ft. torque
 6-speed automatic TorqShift® series transmission with overdrive
 Ford Chassis – 14,500-pound GVWR
 Ford Chassis – 22,000-pound GCWR
 Ford Chassis – 7,500-pound hitch with 750-lb tongue capacity and 7-pin plug
 120-amp alternator
 55-gallon fuel tank
 Driver and passenger air bags
 Power anti-lock brakes with power steering
 Tilt steering wheel
 Auxiliary start switch
 A/C and cruise control
 Remote-controlled, side-view mirrors
 Power windows and door locks
 Third brake light

STANDARD EXTERIOR EQUIPMENT

TuffShell™ vacuum-bonded, laminated floor, sidewalls and roof
 Bead-foam insulation (R-15 max roof, R-9 max floor, R-5 max walls)
 Aluminum running boards
 Fiberglass, radius-cornered entrance door

with screen door
 Electric-powered entrance step
 Pass-through storage compartment with light (select models)
 Onan 4,000-watt MicroQuiet generator
 42-lb. propane tank (12.2 GAL)
 120V G.F.C.I.-protected exterior receptacle
 12V electrical system with 120V, 60-amp power converter
 30-amp power cord
 Outside shower
 4" bumper-tube sewer hose storage
 Roof ladder
 Leveling jack prep
 One-piece seamless fiberglass roof

STANDARD INTERIOR EQUIPMENT

84" ceiling height
 Ball bearing drawer guides
 3-burner range with 9,000-BTU SuperBurner and piezo igniter
 Convection microwave oven (N/A 31L)
 12V demand water pump
 6 gallon gas/electric DSI auto-ignition water heater
 Water filtration system
 Entegra-exclusive easy operation legless dinette table (N/A 24B)
 Lap safety belts on all living area seats
 Linoleum flooring
 Interior command center
 Cable TV hookup with RG-6 coax
 Digital antenna with signal booster
 15,000-BTU ducted air conditioner
 30,000-BTU furnace with wall thermostat with auto-ignition
 Shower with decorative surround and glass shower door
 Removable clothing rod in shower
 Skylight in shower
 Porcelain toilet with foot flush
 Queen-sized bed with bedspread
 Under-bed storage (select models)
 Large wardrobes
 Full cab-over bunk with headboard (750-lb. rating)
 Bunk beds (300-lb. rating) (31L)

OPTIONS

Hydraulic leveling jacks
 Bedroom TV
 (2) 24" LED TV's in bunk area



THE ENTEGRA DIFFERENCE

- One-piece seamless front cap** for increased durability and protection
- 82-inch x 30-inch automotive-bonded panoramic front window**
- 750-pound overhead bunk capacity** offers nearly 250 pounds more than the industry average for greater safety and peace of mind
- One-piece seamless fiberglass roof**
- Integrated third brake light** improves safety on the road
- Seatbelts** in every seating position
- Frameless windows** make exterior maintenance easier than ever and give the unit a sleek, modern look
- Full pass-through storage** for easy packing and unpacking (select models)

For a full list of standards and options, use your camera app to scan code.

QWEST



ESTEEM



ODYSSEY



ENTEGRACOACH, INC., P.O. BOX 460, MIDDLEBURY, IN 46540

WWW.ENTEGRACOACH.COM



Gross Vehicle Weight Rating (GVWR): The maximum permissible weight of the motorcoach, including the Unloaded Vehicle Weight (UVW) plus passengers, personal items, all cargo, fluids, options and dealer-installed accessories. The GVWR is equal to or greater than the sum of the UVW and the Cargo Carrying Capacity. Gross Axle Weight Rating (GAWR): The maximum allowable weight each axle assembly is designed to carry, as measured at the tires, therefore including the weight of the axle assembly itself. Gross Combined Weight Rating (GCWR): The maximum allowable combined weight of the motorcoach used as a tow vehicle and the attached towed vehicle.

Entegra Coach, Inc. | P.O. Box 460 | Middlebury, IN 46540 See dealer for further information and prices. All information in this brochure and on www.entegracoach.com is the latest available at the time of publication approval. Entegra Coach reserves the right to make changes and to discontinue models without notice or obligation. Photography may show optional equipment or props used for decoration purposes only. RVs built for sale in Canada may differ to conform to Canadian codes. ENTEGRA COACH, JAYCO and the JAYCO BIRD IN FLIGHT are registered trademarks of Jayco, Inc. Printed in U.S.A. 39K 7/18 © 2018 Entegra Coach, Inc. 274889



A year's access to Coach-Net™—the country's largest RV emergency road service.

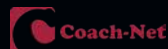

LAMESA REC
VAN

LaMesaRV.com
800-496-8778

